



Ersatzteilliste
Spare Parts List

2018-09

MS43004U
EM4351UH

MS43004U, EM4351UH (D, GB)

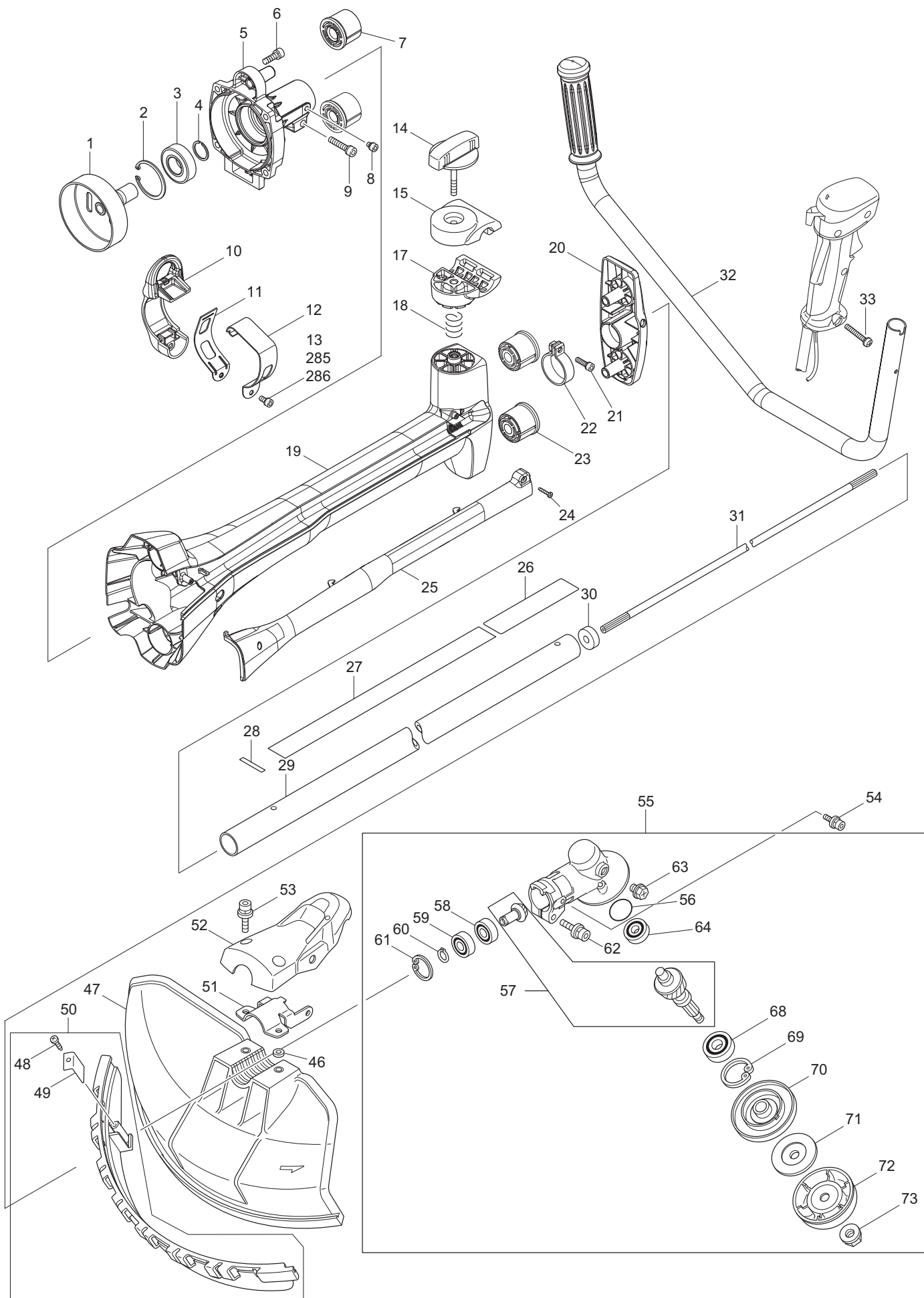

MS43004U, EM4351UH

1

Hauptrohr, Griff, Schutzhaube,
Getriebegehäuse
Pipe, handle, protector, gear case

Seite / Page	Pos.	MS43004U	EM4351UH	Teil-Nr. Part No.	Hinweise Notes	Bezeichnung	Spezifikation Specification	Description
1	1	1	1	168712-2		KUPPLUNGSTROMMEL		CLUTCH DRUM
1	2	1	1	962201-7		SICHERUNGSRING	(INT) R-42	RETAINING RING
1	3	1	1	211387-7		KUGELLAGER	6004LLU	BALL BEARING
1	4	1	1	961090-7		SICHERUNGSRING	(EXT) WR-20	RETAINING RING
1	5	1	1	318849-7		KUPPLUNGSGEHÄUSE		CLUTCH CASE
1	6	4	4	367922331		SCHRAUBE	M6X20	HEX. SOCKET HEAD BOLT
1	7	2	2	424488-4		SCHWINGUNGSDÄMPFER		BUFFER RUBBER
1	8	1	1	367922201		INNEN-6 KANT-SCHRAUBE	M5X8	HEX. SOCKET HEAD BOLT
1	9	1	1	922351-0		6KT-SCHRAUBE	M6X30	HEX. SOCKET HEAD BOLT
1	10	1	1	456033-7	2014-12 =>	TRAGEGURTAUFNAHME		HANGER
1	10	1	1	453525-7	=> 2014-11	TRAGEGURTAUFNAHME		HANGER
1	11	1	1	346572-4		SCHELLE	L	HANGER HOLDER
1	12	1	1	346571-6		SCHELLE	R	HANGER HOLDER
1	13	1	1	266957-7	2014-12 =>	FLÜGELSCHRAUBE	M5x20	WING BOLT
1	13	1	1	265991-4	=> 2014-11	6KT-SCHRAUBE	M5x12	HEX. SOCKET HEAD BOLT
1	14	1	1	168796-0		KNOPF	57	KNOB
1	15	1	1	367318425		KLEMMSCHALE		HANDLE CLAMP
1	17	1	1	318860-9		KLEMMSCHALE		HANDLE CLAMP
1	18	1	1	367233309		DRUCKFEDER	17	COMPRESSION SPRING
1	19	1		367453541		GRIFFANBINDUNG	DOLMAR	PIPE HOUSING
1	19		1	453526-5		GRIFFANBINDUNG	MAKITA	PIPE HOUSING
1	20	1		367453543		KLEMMSTÜCK	DOLMAR	CLAMPING PIECE
1	20		1	453528-1		KLEMMSTÜCK	MAKITA	CLAMPING PIECE
1	21	1	1	367922226		SCHRAUBE	M5X18	HEX. SOCKET HEAD BOLT
1	22	1	1	346590-2		KLEMMSCHELLE	33	PIPE CLAMP
1	23	2	2	424488-4		SCHWINGUNGSDÄMPFER		BUFFER RUBBER
1	24	2	2	266429-2		SCHNEIDSCHRAUBE	3X16	TAPPING SCREW
1	25	1		453542-7		ABDECKUNG	DOLMAR	HOUSING COVER
1	25		1	453527-3		ABDECKUNG	MAKITA	HOUSING COVER
1	26	1		660893388		FIRMENSCHILD	DOLMAR LOGO	LABEL
1	26		1	819312-8		FIRMENSCHILD	Makita LOGO	LABEL
1	27	1		367898810		SICHERHEITSAUFKLEBER		CAUTION LABEL
1	27		1	367801067		SICHERHEITSAUFKLEBER	RU	CAUTION LABEL
1	27		1	898809-0		SICHERHEITSAUFKLEBER		CAUTION LABEL
1	28	1	1	801D20-9		SCHILD	SERIAL NO.	LABEL
1	28		1			SCHILD	SERIAL NO. (RU)	LABEL
1	29	1	1	141335-1		SCHAFTROHR KPL.		SHAFT PIPE COMPLETE
1	30	1	1	443146-3		FILZRING	8	FELT RING
1	31	1	1	326153-0		WELLE		SHAFT
1	32	1	1	141584-0		GRIFFROHR KPL.		HANDLE COMPLETE
1	33	1	1	911256-9		FLACHKOPFSCHRAUBE	M5X35	PAN HEAD SCREW
1	46	2	2	413143-3		SCHEIBE		WASHER
1	47	1	1	452259-9		SCHUTZHAUBE	ANSI standard	PROTECTOR
1	48	1	1	266326-2		SCHNEIDSCHRAUBE	4X18	SCREW
1	49	1	1	346074-0		FADENMESSER		LINE CUTTER
1	50	1	1	135398-7		SCHUTZLEISTE KPL.	2010 =>	PROTECTOR EXTENSION ASSY
1	51	1	1	346072-4		SCHELLE FÜR SCHUTZHAUBE		PROTECTOR CLAMP
1	52	1	1	451090-0		ABDECKUNG		PROTECTOR COVER
1	53	2	2	266579-3		INNEN-6 KANT-SCHRAUBE	M6x30	HEX. SOCKET HEAD BOLT
1	54	2	2	266865-2		SCHRAUBE	M5X14	H.S.H.BOLT WITH WR
1	55	1	1	126310-8		GETRIEBE KPL.		GEAR CASE ASSY
1	56	1	1	213459-4		O-RING	32	O-RING
1	57	1	1	367187644		SPINDEL KPL.		CUTTER SHAFT SET
1	58	1	1	367211064		KUGELLAGER	6000	BALL BEARING
1	59	1	1	211062-5		RILLENKUGELLAGER	6000 2Z	BALL BEARING
1	60	1	1	961006-2		SICHERUNGSRING	S-10	RETAINING RING
1	61	1	1	962105-3		SICHERUNGSRING	R-26	RETAINING RING
1	62	1	1	367922353		SCHRAUBE	M6X30	HEX. SOCKET HEAD BOLT
1	63	1	1	367265590		SCHRAUBE	M8X10	+HEX.BOLT WITH R
1	64	1	1	210159-7		RILLENKUGELLAGER	629ZZ	BALL BEARING
1	68	1	1	367210116		KUGELLAGER	6201LLU	BALL BEARING
1	69	1	1	367962151		SICHERUNGSRING	R-32	RETAINING RING
1	70	1	1	332114-0		AUFNAHMESCHEIBE	ø 25,4	RECEIVE WASHER
1	70	1	1	332051-8	ACC.	AUFNAHMESCHEIBE FÜR MEISSELZAHN-SÄGEBLATT	ø 20	RECEIVE WASHER CHISEL TYPE SAW BLADE
1	71	1	1	346355-2		DRUCKSCHEIBE		CLAMP WASHER
1	72	1	1	168526-9		GLEITTELLER		SLIDING CUP
1	73	1	1	264025-0		SECHSKANTMUTTER	M10x1,25 LH	HEX NUT
1	285	1	1	257903-1	2014-12 =>	SICHERUNGSSCHEIBE	E-2.3	STOP RING
1	286	1	1	388100500	2014-12 =>	SCHEIBE	5	WASHER

74

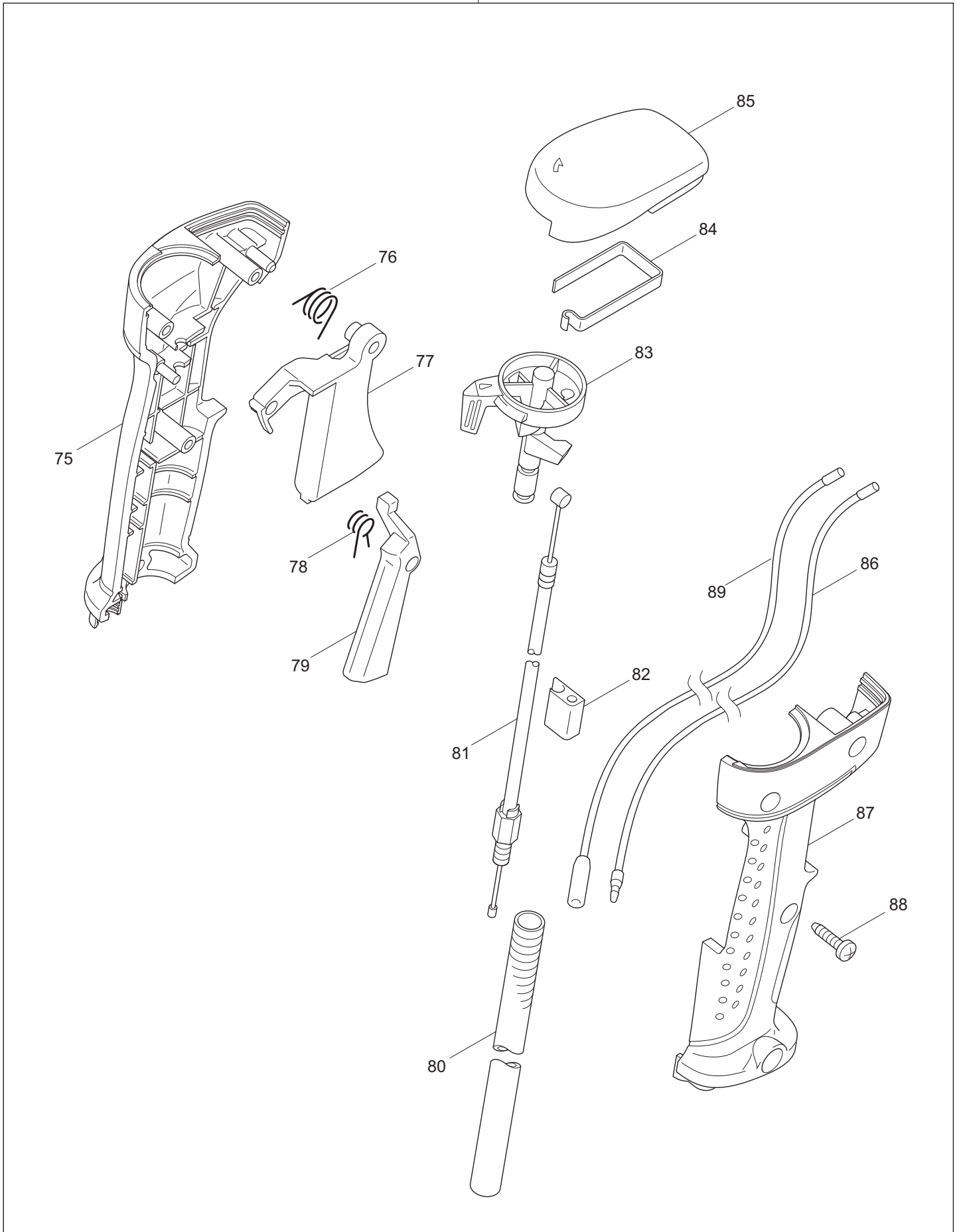

MS43004U, EM4351UH

2

Bedienungshandgriff kpl.
Control lever ass'y

Seite / Page	Pos.	MS43004U	EM4351UH	Teil-Nr. Part No.	Hinweise Notes	Bezeichnung	Spezifikation Specification	Description
2	74	1	1	126114-8		BEDIENUNGSHANDGRIFF KPL.		CONTROL LEVER ASS'Y
2	75	1	1	183A09-4	2015 =>	GRIFFSCHALEN, SATZ		LEVER CASE, SET
2	75	1	1	188657-8	=> 2014	GRIFFSCHALEN, SATZ		LEVER CASE, SET
2	76	1	1	367233540		TORSIONSFEDER	11	TORSION SPRING
2	77	1	1	451084-5		GASHEBEL		THROTTLE LEVER
2	78	1	1	367233541		TORSIONSFEDER	7	TORSION SPRING
2	79	1	1	367451083		GASHEBELSPERRE		STOP LEVER
2	80	1	1	367453524		FALTENSCHLAUCH		CORRUGATED TUBE
2	81	1	1	367168711		BOWDENZUG		CONTROL CABLE
2	82	1	1	367451081		KABELKLEMME		CABLE HOLDER
2	83	1	1	367451500		SCHALTHEBEL		SWITCH LEVER
2	84	1	1	232251-9		BLATTFEDER		LEAF SPRING
2	85	1	1	367455723		SCHALTERDECKEL		SWITCH COVER
2	86	1	1	367638972		KABEL		LEAD UNIT
2	87	1	1	183A09-4	2015 =>	GRIFFSCHALEN, SATZ		LEVER CASE, SET
2	87	1	1	188657-8	=> 2014	GRIFFSCHALEN, SATZ		LEVER CASE, SET
2	88	3	3	266326-2		SCHNEIDSCHRAUBE	4X18	SCREW
2	89	1	1	638973-3		KABEL		LEAD UNIT

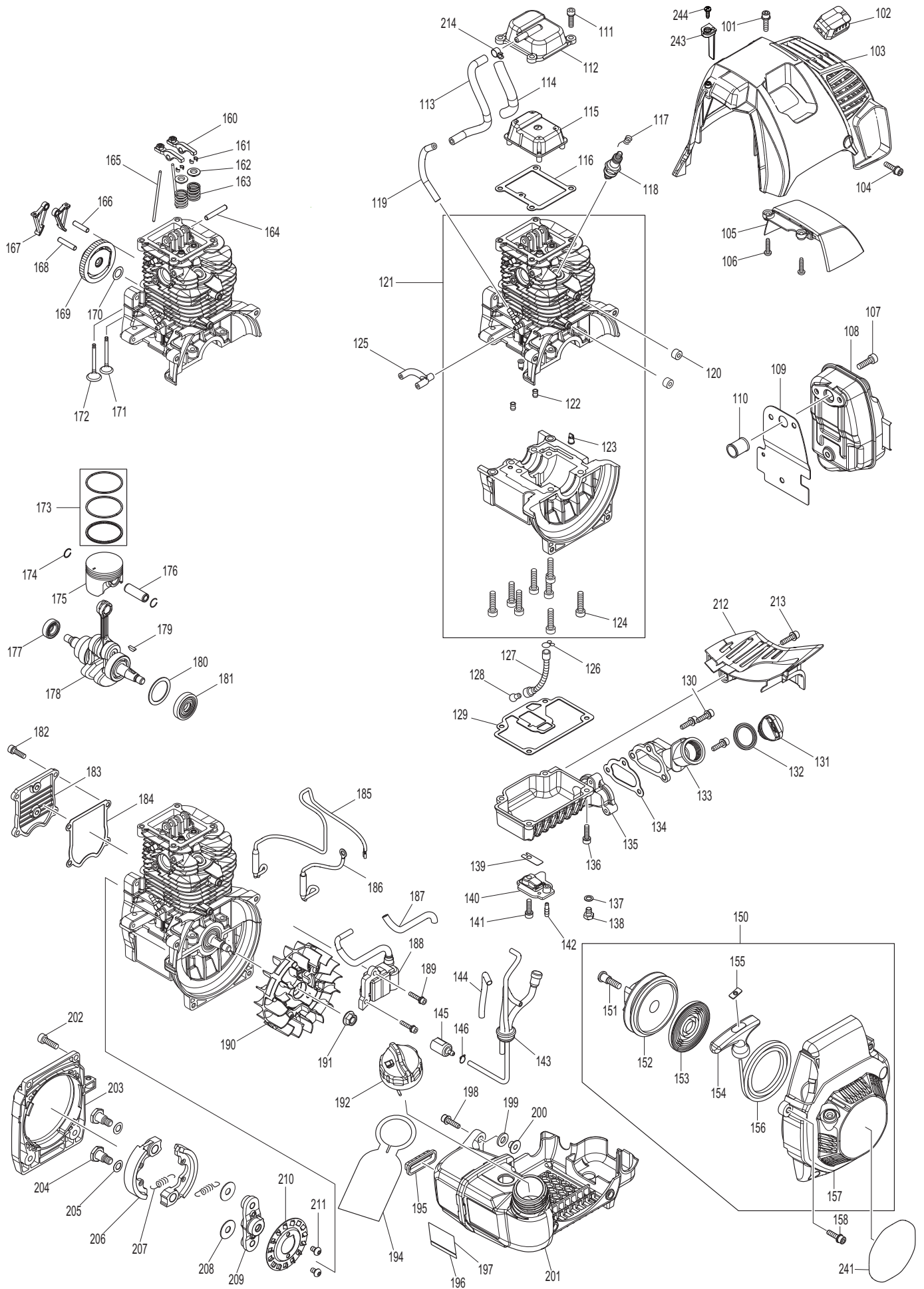

Seite / Page	Pos.	MS43004U	EM4351UH	Teil-Nr. Part No.	Hinweise Notes	Bezeichnung	Spezifikation Specification	Description
3	101	1	1	320922233		INNEN-6KT-SCHRAUBE	M5X20	HEX. SOCKET HEAD BOLT
3	102	1	1	424302-4		STECKERKAPPE		PLUG CAP
3	103	1		367453544	=> 2013-12	ZYLINDERHAUBE		CYLINDER COVER
3	103	1		367455108	2014-01 =>	ZYLINDERHAUBE	DOLMAR	CYLINDER COVER
3	103		1	453535-4	=> 2013-12	ZYLINDERHAUBE		CYLINDER COVER
3	104	1	1	320922233		INNEN-6KT-SCHRAUBE	M5X20	HEX. SOCKET HEAD BOLT
3	105	1	1	453536-2		VERBRENNUNGSSCHUTZ		MUFFLER COVER
3	106	2	2	660265995		GEWINDESCHNEIDSCHRAUBE	4X18	TAPPING SCREW
3	107	3	3	367922332		INNEN-6KT-SCHRAUBE	M6X20	HEX. SOCKET HEAD BOLT
3	108	1	1	168715-6		SCHALLDÄMPFER		EXHAUST MUFFLER
3	109	1	1	346574-0		DICHTUNG SCHALLDÄMPFER		MUFFLER GASKET
3	110	1	1	331987-8		DISTANZBUCHSE		EXHAUST PORT SPACER
3	111	4	4	367922226		SCHRAUBE	M5X18	HEX. SOCKET HEAD BOLT
3	112	1	1	367318850		ABDECKUNG FÜR KIPPHEBEL, AUSSEN		ROCKER COVER OUTER
3	113	1	1	422091-5		SCHLAUCH	5-160	TUBE
3	114	1	1	454424-6		FALTENSCHLAUCH		CORRUGATED TUBE
3	115	1	1	367453529		ABDECKUNG FÜR KIPPHEBEL, INNEN		ROCKER COVER INNER
3	116	1	1	162335-8		DICHTUNG, ABDECKUNG FÜR KIPPHEBEL		ROCKER COVER GASKET
3	117	1	1	324891-8		STECKERKAPPENFEDER		PLUG CAP SPRING
3	118	1		196721-1		MOTORWARTUNG-SET	SET (MS-430.4 U, MS-4300.4 U) INC. 118,145,218,220,A 03	ENGINE MAINTENANCE KIT
3	118	1	1	965603030		ZÜNDKERZE	NGK CMR6A	SPARK PLUG
3	119	1	1	422090-7		SCHLAUCH	3-85	TUBE
3	120	2	2	367452049		DISTANZRING		SPACER
3	121	1		135659-5	2015 =>	ZYLINDERBLOCK-SET		CYLINDER BLOCK ASSEMBLY
3	121	1	1	135557-3	=> 2014	ZYLINDERBLOCK-SET		CYLINDER BLOCK ASSEMBLY
3	121	1	1	123759-3		MOTORBLOCK	INC. 111,112,115,116,1 19,122-124,127,12 9-142,160-176,178 ,182-184	ENGINE BLOCK ASSEMBLY
3	122	2	2	424200-2		DISTANZBUCHSE		SPACER
3	123	2	2	367424201		RÜCKSCHLAGVENTIL		CHECK VALVE
3	124	8	8	922342-1		INNEN-6 KANT-SCHRAUBE	M6X25	HEX. SOCKET HEAD BOLT
3	125	1	1	422099-9		ROHR		PIPE
3	126	1	1	367282020		SCHLAUCHKLEMME		HOSE CLAMP
3	127	1	1	424301-6		ÖLLEITUNG		OIL TUBE
3	128	1	1	325666-8		GEWICHT FÜR ÖLLEITUNG		OIL WEIGHT
3	129	1	1	162337-4		DICHTUNG		OIL CASE GASKET
3	130	3	3	374905945		SCHRAUBE	M5X18	SOCKET HEAD BOLT
3	131	1	1	452047-4		OLDECKEL		OIL CAP
3	132	1	1	0213229990		DICHTUNG		GASKET
3	133	1	1	453538-8		ÖLLEITUNG		OIL PIPE
3	134	1	1	162338-2		DICHTUNG		OIL PIPE GASKET
3	135	1	1	318854-4		ÖLWANNE		OIL CASE
3	136	4	4	367922226		SCHRAUBE	M5X18	HEX. SOCKET HEAD BOLT
3	137	1	1	346305-7		DICHTUNG		GASKET
3	138	1	1	367266611		6KT-SCHRAUBE	M6X8	HEXAGON BOLT
3	139	1	1	320346398		EINLASSMEMBRAN (REEDVALVE)		LEAD VALVE
3	140	1	1	367318851		STOPPER FÜR REEDVALVE		RETAINER PLATE
3	141	1	1	367922226		SCHRAUBE	M5X18	HEX. SOCKET HEAD BOLT
3	142	1	1	367325665		ANSCHLUßSTÜCK		JOINT PIPE
3	143	1	1	168724-5		SCHLAUCH KPL.		TUBE COMPLETE
3	144	1	1	454426-2		SPIRALSCHLAUCH	6-80	SPIRAL TUBE
3	145	1	1	163518-3		BENZINFILTER		GASOLINE FILTER
3	145	1		196721-1		MOTORWARTUNG-SET	SET (MS-430.4 U, MS-4300.4 U) INC. 118,145,218,220,A 03	ENGINE MAINTENANCE KIT
3	146	1	1	367282020		SCHLAUCHKLEMME		HOSE CLAMP
3	150	1	1	126119-8		STARTER KPL.		STARTER COVER ASS'Y
3	151	1	1	320266634		FESTSTELLSCHRAUBE	M6X20	SET SCREW
3	152	1	1	452288-2		SEILTROMMEL		REEL
3	153	1	1	232262-4		RÜCKHOLFEDER		SPIRAL SPRING
3	154	1	1	5315001020		ANWERFGRIF		STARTER KNOB
3	155	1	1	5315001030		SCHEIBE		STOPPER
3	156	1	1	444027-4		ANWERFSEIL		STARTER ROPE
3	157	1	1	367453534		ANWERFGEHÄUSE		STARTER COVER
3	158	4	4	320922233		INNEN-6KT-SCHRAUBE	M5X20	HEX. SOCKET HEAD BOLT
3	160	2	2	126116-4		KIPPHEBEL KPL.		ROCKER ARM ASS'Y
3	161	4	4	331990-9		SPLINT		COTTER

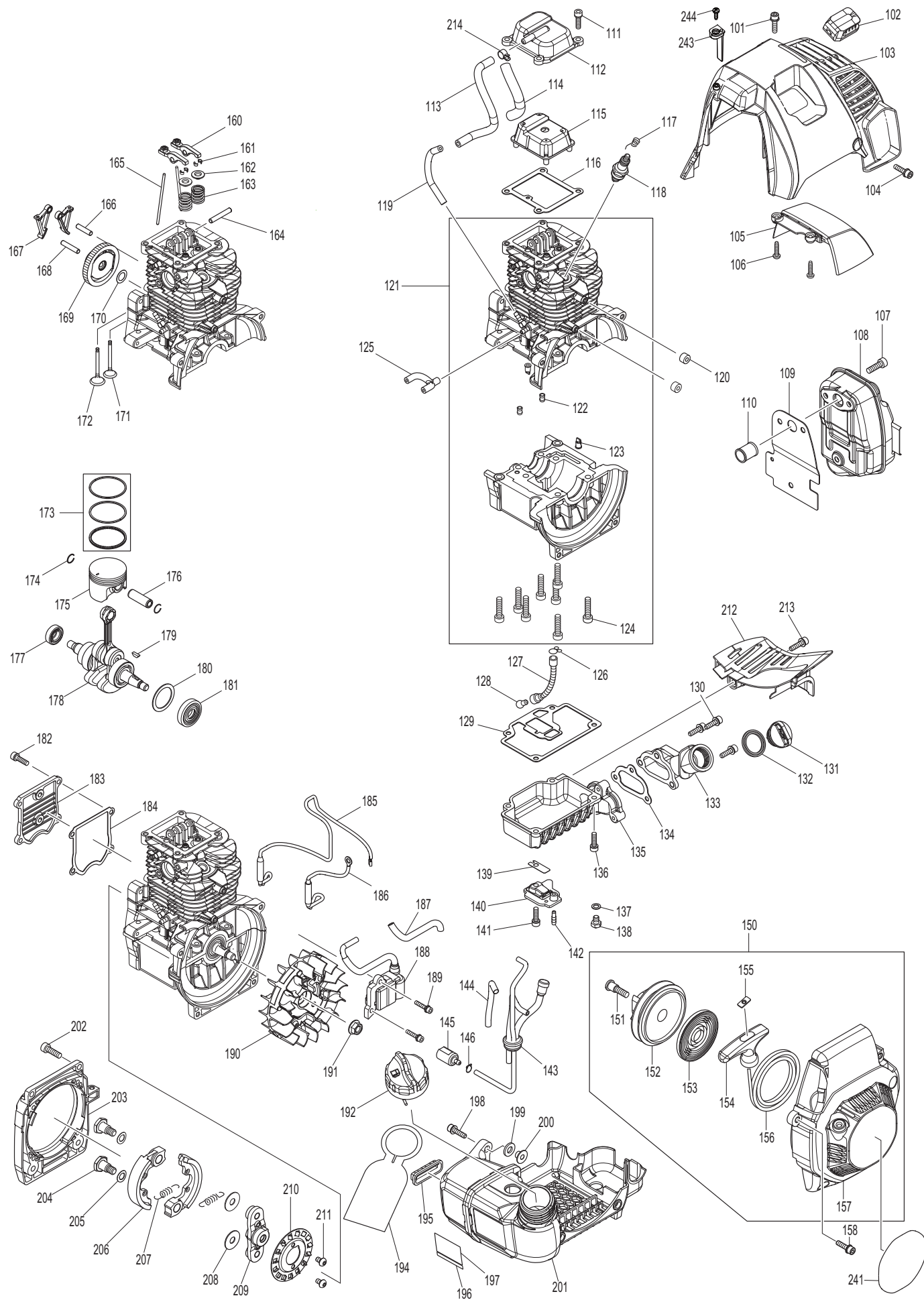

Seite / Page	Pos.	MS43004U	EM4351UH	Teil-Nr. Part No.	Hinweise Notes	Bezeichnung	Spezifikation Specification	Description
3	162	2	2	331991-7		FEDERTELLER		SPRING RETAINER
3	163	2	2	234238-7		DRUCKFEDER	11	COMPRESSION SPRING
3	164	1	1	256200-2		STIFT	5	PIN
3	165	2	2	256866-8		STÖSSELSTANGE	2.5	ROD
3	166	1	1	268238-5		STIFT	5	PIN
3	167	2	2	313236-5		NOCKENHEBEL		CAM LIFTER
3	168	1	1	256186-0		STIFT	5	PIN
3	169	1	1	126571-0		NOCKENRAD KPL.		CAM GEAR ASSY
3	170	1	1	261127-3		SCHLEIBE	10 (TEFLON)	WASHER
3	171	1	1	326575-4	2015 =>	AUSLASSVENTIL		EXHAUST VALVE
3	171	1	1	326158-0	=> 2014	AUSLASSVENTIL		EXHAUST VALVE
3	172	1	1	326157-2		EINLASSVENTIL		INTAKE VALVE
3	173	1	1	196667-1		KOLBENRING-SATZ		PISTON RING SET
3	174	2	2	367233983		SPRENGRING		CLIP
3	175	1	1	318853-6		KOLBEN		PISTON
3	176	1	1	268285-6		KOLBENBOLZEN		PISTON PIN
3	177	1	1	213685-5		ÖLDICHTUNG	12	OIL SEAL
3	178	1	1	126121-1		KURBELWELLE KPL.	INC. 177,180,181	CRANKSHAFT ASSY
3	179	1	1	367254040		SCHLEIBENFEDER	3	WOODRUFF KEY
3	180	1	1	267425-3		FLACHSCHEIBE	26	FLAT WASHER
3	181	1	1	213537-0		ÖLDICHTUNG	12	OIL SEAL
3	182	4	4	367266086		INNEN-6KT-SCHRAUBE	M5X16	HEX. SOCKET HEAD BOLT
3	183	1	1	318856-0		ABDECKUNG F.NOCKENRAD		CAMGEAR COVER
3	184	1	1	162334-0		DICHTUNG		CAM GEAR COVER GASKET
3	185	1	1	367638974		KABEL		LEAD UNIT
3	186	1	1	638975-9		KABEL		LEAD UNIT
3	187	1	1	444021-6		SCHLAUCH		TUBE
3	188	1	1	168714-8		ZUNDSPULE		IGNITION COIL
3	189	2	2	367266602		INNEN-6KT-SCHRAUBE	M4X20	HEX. SOCKET HEAD BOLT
3	190	1	1	367126122		POLRAD KPL.		FLYWHEEL COMPLETE
3	191	1	1	374109107		BUNDMUTTER		FLANGE NUT
3	192	1	1	125728-0		KRAFTSTOFFTANKDECKEL KPL.		FUEL TANK CAP ASSEMBLY
3	194	1	1	367810455		HINWEISSCHILD F. KRAFTSTOFFART		CAUTION PLATE
3	195	1	1	374424081		GUMMIDAMPFER		VIBRATION DAMPER
3	196	1	1	897220-3		SCHILD	SERIAL NO.	LABEL
3	197	1	1			ABGASAUFKLEBER	EU	GAS EMISSION APPROVAL LABEL
3	198	1	1	320922233		INNEN-6KT-SCHRAUBE	M5X20	HEX. SOCKET HEAD BOLT
3	199	1	1	367261152		GUMMISCHEIBE	8	RUBBER WASHER
3	200	1	1	331988-6		DISTANZBUCHSE		SPACER
3	201	1	1	168875-4		KRAFTSTOFFTANK		FUEL TANK
3	202	4	4	367922332		INNEN-6KT-SCHRAUBE	M6X20	HEX. SOCKET HEAD BOLT
3	203	1	1	318852-8		MOTORSOCKEL		ENGINE BASE
3	204	2	2	367266597		6KT-BUNDSCHRAUBE	M8	SHOULDER HEX. BOLT
3	205	2	2	367267832		WELLENSCHEIBE	10	WAVE WASHER
3	206	2	2	313238-1		FLIEHGEWICHT		CLUTCH SHOE
3	207	2	2	232290-9		ZUGFEDER	6	TENSION SPRING
3	208	2	2	367267428		FLACHSCHEIBE	8	FLAT WASHER
3	209	1	1	313239-9		KUPPLUNGSNABE		CLUTCH HUB
3	210	1	1	346576-6		LÜFTERTELLER		FAN PLATE
3	211	2	2	266461-6		HALBRUNDSCHRAUBE	M5X8	H.S.BUTTON HEAD SCREW
3	212	1	1	453530-4		VERBRENNUNGSSCHUTZ		MUFFLER PLATE
3	213	1	1	374905945		SCHRAUBE	M5X18	SOCKET HEAD BOLT
3	214	1	1	367345918		SCHLAUCHKLEMME		HOSE CLAMP
3	240	1	1	819430-2	ohne Abb., w/o picture	SICHERHEITSANHÄNGER	DE, FR	CAUTION TAG
3	240	1		367819431	ohne Abb., w/o picture	SICHERHEITSANHÄNGER	PL, AT, SE	CAUTION TAG
3	241	1		898806-6		SCHILD	MS-4300.4U	LABEL
3	241		1	898805-8	ohne Abb., w/o picture	SCHILD	EM4351UH	LABEL
3	243	1		367455102	2014-01 =>	EINSATZ SOMMER / WINTER		CHANGE PLATE
3	244	1		266385-6	2014-01 =>	SCHNEIDSCHRAUBE	4x14	TAPPING SCREW

Maschinen älterer Bauart
Previous models

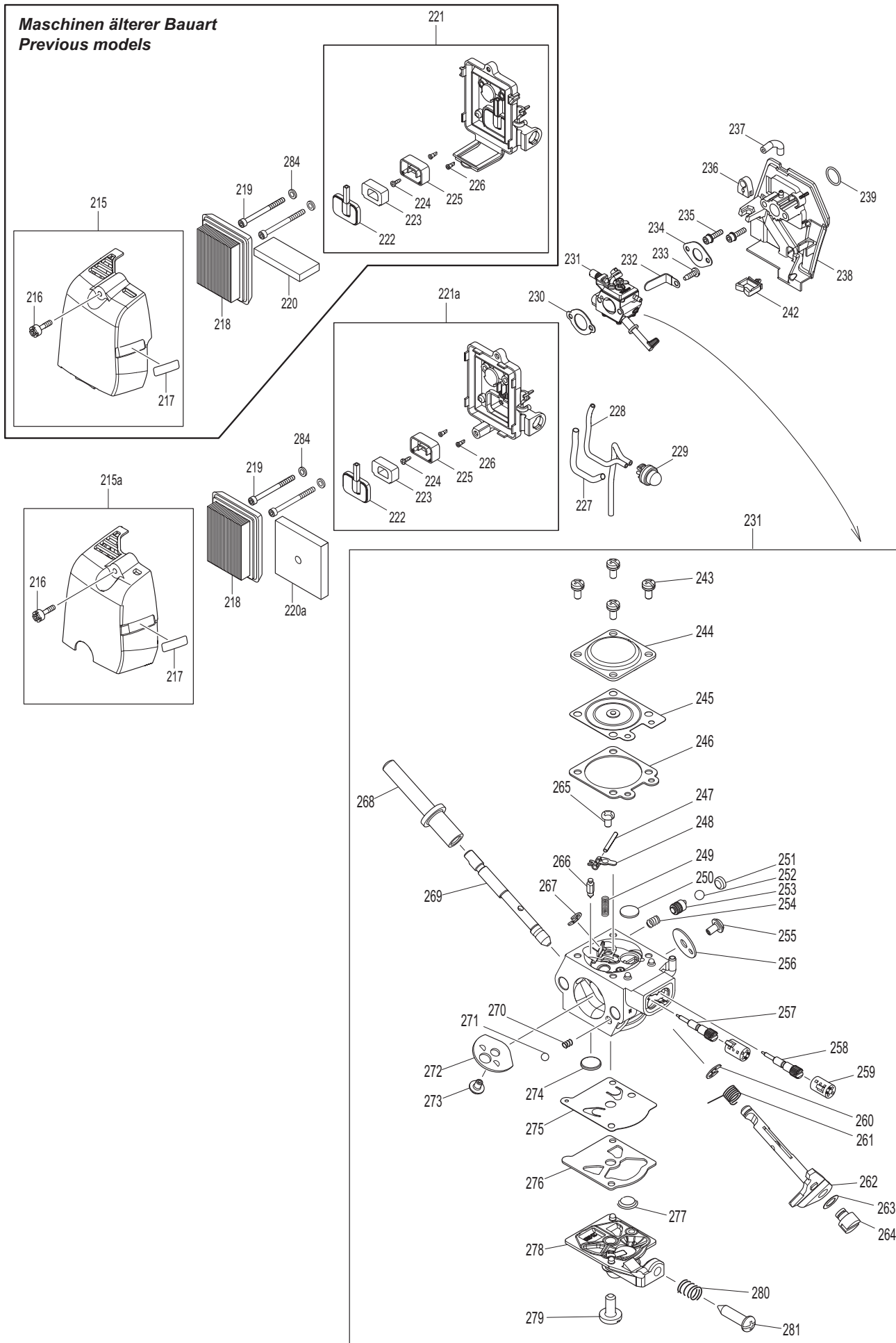

Seite / Page	Pos.	MS43004U	EM4351UH	Teil-Nr. Part No.	Hinweise Notes	Bezeichnung	Spezifikation Specification	Description
4	215	1	1	126118-0	=> 2013-12	LUFTFILTERDECKEL KPL.		CLEANER COVER ASSEMBLY
4	215	1	1	126474-8	=> 2017-01	LUFTFILTERDECKEL KPL.		CLEANER COVER ASSEMBLY
4	215	1	1	801S44-5		HINWEISSCHILD		INDICATION LABEL
4	215 a	1	1	126523-1	2017-02 =>	LUFTFILTERDECKEL KPL.		CLEANER COVER ASSEMBLY
4	216	1/2	1/2	266743-6		INNEN-6KT-SCHRAUBE	M5X20	HEX. SOCKET HEAD BOLT
4	217	1	1	367898844		HINWEISSCHILD		INDICATION LABEL
4	218	1	1	442181-8		LUFTFILTER		ELEMENT AIR CLEANER
4	218	1	1	196721-1		MOTORWARTUNG-SET	SET (MS-430.4 U, MS-4300.4 U) INC. 118,145,218,220,A 03	ENGINE MAINTENANCE KIT
4	219	2	2	266618-9		SCHRAUBE	M5X60	H.S.BUTTON HEAD BOLT
4	220	1	1	443173-0	=> 2017-01	LUFTFILTER		ELEMENT AIR CLEANER
4	220	1	1	196721-1		MOTORWARTUNG-SET	SET (MS-430.4 U, MS-4300.4 U) INC. 118,145,218,220,A 03	ENGINE MAINTENANCE KIT
4	220 a	1	1	443196-8	2017-02 =>	LUFTFILTER		ELEMENT AIR CLEANER
4	220 a	1	1	196721-1		MOTORWARTUNG-SET	SET (MS-430.4 U, MS-4300.4 U)	ENGINE MAINTENANCE KIT
4	221	1	1	126117-2	=> 2017-01	LUFTFILTERBODEN KPL. ROT		AIR CLEANER PLATE ASS'Y
4	221 a	1	1	123994-3	2017-02 =>	LUFTFILTERBODEN KPL.		AIR CLEANER PLATE ASS'Y
4	222	1	1	162346-3		ÖLSEPARATOR		SEPARATOR PLATE
4	223	1	1	352020-3		NETZGEWEBE		SEPARATOR MESH
4	224	1	1	320266007		GEWINDESCHNEIDSCHRAUBE	3X10	TAPPING SCREW BIND
4	225	1	1	453865-3		SEPERATORGEHÄUSE		SEPARATOR CASE
4	226	2	2	424316-3		RÜCKSCHLAGVENTIL		CHECK VALVE
4	227	1	1	454425-4		SPIRALSCHLAUCH	6-100	SPIRAL TUBE
4	228	1	1	422074-5		SCHLAUCH	3-120	TUBE
4	229	1	1	168398-2		KRAFTSTOFFPUMPE	PRIMER	PRIMER PUMP
4	230	1	1	442196-5		DICHTUNG		CARBURATOR GASKET
4	231	1	1	126339-4		VERGASER KPL.		CARBURETOR ASSEMBLY
4	232	1	1	367345963		KLEMMSCHELLE		CLAMP
4	233	1	1	660266388		SCHNEIDSCHRAUBE	5X16	SCREW
4	234	1	1	442197-3		DICHTUNG		CARBURATOR GASKET
4	235	2	2	382905973		SCHRAUBE	M5X20 W/W&SW	SOCKET HEAD BOLT
4	236	1	1	424489-2		GUMMITÜLLE		GROMMET
4	237	1	1	422080-0		SCHLAUCH	3-35	TUBE
4	238	1	1	142736-6	2014-01 =>	ZWISCHENFLANSCH KPL.		INSULATOR COMPLETE
4	238	1	1	142128-9	=> 2013-12	ZWISCHENFLANSCH KPL.		INSULATOR COMPLETE
4	239	1	1	213642-3		O-RING	18	O-RING
4	240	1		819430-2	ohne Abb.	SICHERHEITSANHÄNGER	DE, FR	CAUTION TAG
4	241	1		898806-6	ohne Abb.	SCHILD	MS-4300.4U	LABEL
4	242	1	1	451825-9		KLAMMER		CLAMP
4	243	1	1	WJ00096589		SCHRAUBE KPL.		SCREW ASS'Y
4	244	1	1	WJ00021158		ABDECKUNG		COVER
4	245	1	1	168620-7		STEUERMEMBRAN		METERING DIAPHRAGM
4	246	1	1	442183-4		DICHTUNG		GASKET
4	247	1	1	WJ00014477		STIFT		PIN
4	248	1	1	WJ00016648		HEBEL		LEVER
4	249	1	1	WJ00983248		FEDER		SPRING
4	250	1	1	5416036160		VERSCHLUSSSCHEIBE		PLUG-WELCH
4	251	1	1	WJ00088229		KAPPE		PLUG-CUP
4	252	1	1	5806084330		STAHLKUGEL		STEEL BALL
4	253	1	1	WJ00160593		BESCHLEUNIGUNGSPUMPE		ACCELERATOR PISTON ASSEMBLY
4	254	1	1	WJ00983305		FEDER		SPRING
4	255	1	1	WJ00963240		SCHRAUBE		SCREW
4	256	1	1	WJ00343562		DROSSELKLAPPE		THROTTLE VALVE
4	257	1	1	WJ01024009	2014-11 =>	VOLLGAS-STELLSCHRAUBE	H	HIGH SPEED NEEDLE
4	257	1	1	WJ01023345	=> 2014-10	VOLLGAS-STELLSCHRAUBE	H	HIGH SPEED NEEDLE
4	258	1	1	WJ01024008	2014-11 =>	LEERLAUF-STELLSCHRAUBE	L	IDLE ADJUSTMENT SCREW
4	258	1	1	WJ01023344	=> 2014-10	LEERLAUF-STELLSCHRAUBE	L	IDLE ADJUSTMENT SCREW
4	259	2	2	5106038120	2014-11 =>	SCHEIBE		WASHER
4	259	2	2	WJ00025162	=> 2014-10	LIMITER CAP		LIMITER CAP
4	259	2	2	WJ00098404	2014-11 =>	FEDER		SPRING
4	260	1	1	257964-1		SICHERUNGSRING	E-3	STOP RING
4	261	1	1	WJ00098494		FEDER		SPRING
4	262	1	1	WJ00224392		DROSSELKLAPPENWELLE KPL.		THROTTLE SHAFT ASSEMBLY
4	263	1	1	413140-9		SCHEIBE		WASHER
4	264	1	1	374600121		NOCKEN		SWIVEL
4	265	1	1	5016004110		SCHRAUBE		SCREW
4	266	1	1	WJ00008282		VENTIL		VALVE

Maschinen älterer Bauart
Previous models

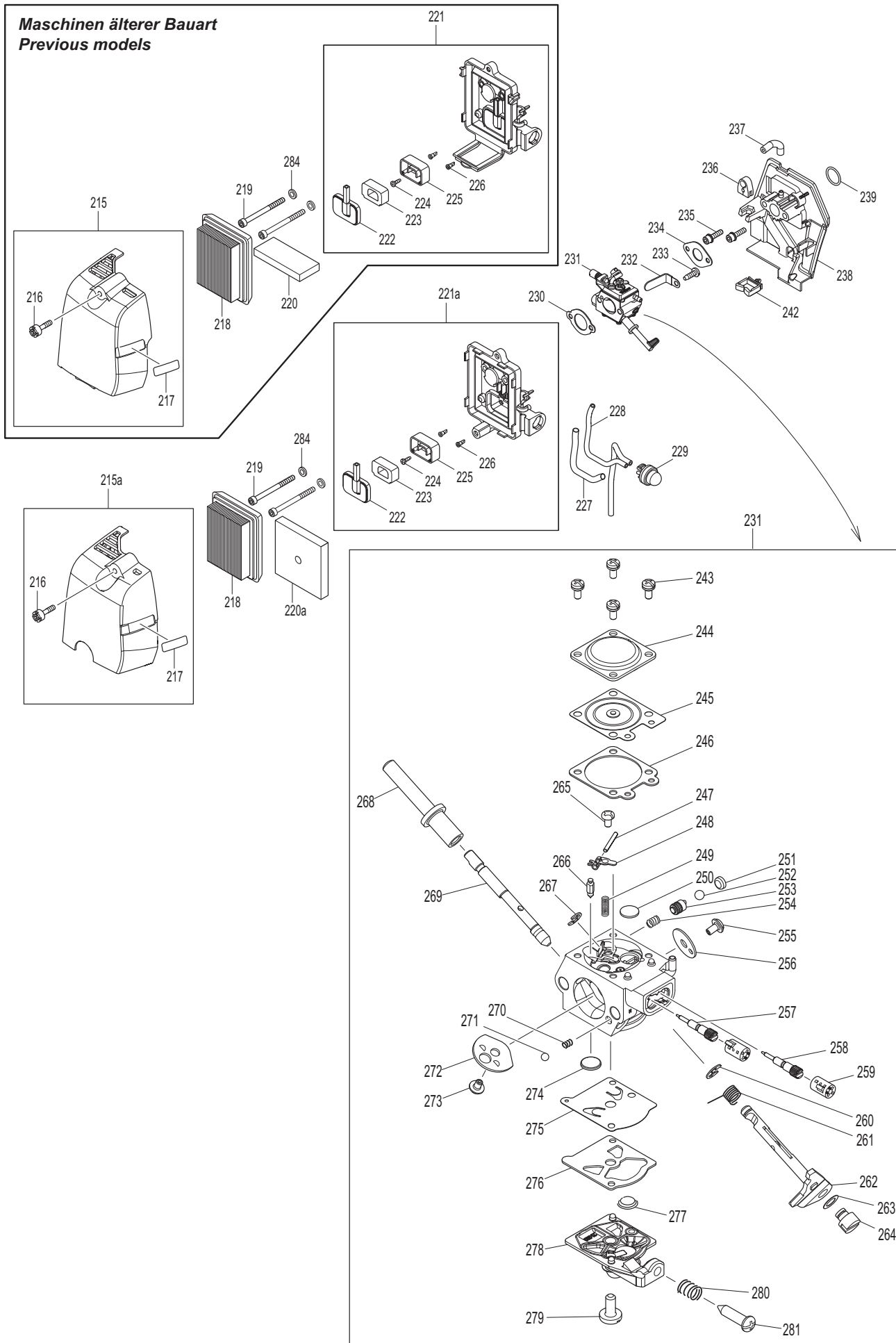

MS43004U, EM4351UH

4

Vergaser, Luftfilter
Carburetor, air filter

Seite / Page	Pos.	MS43004U	EM4351UH	Teil-Nr. Part No.	Hinweise Notes	Bezeichnung	Spezifikation Specification	Description
4	267	1	1	WJ00001673		SICHERUNGSRING		RETAINING RING
4	268	1	1	WJ00183585		CHOKEHEBEL		CHOKE LEVER
4	269	1	1	WJ00044456		CHOKEWELLE		CHOKE SHAFT
4	270	1	1	5806122210		FEDER		SPRING
4	271	1	1	5806122220		KUGEL		BALL
4	272	1	1	WJ00006295		CHOKEKLAPPE		CHOKE SHUTTER
4	273	1	1	WJ00096475		SCHRAUBE		SCREW
4	274	1	1	WJ00014070		SIEB		INLET SCREEN
4	275	1	1	WJ00009589		PUMPENMEMBRAN		PUMP DIAPHRAGM
4	276	1	1	WJ00092228		DICHTUNG		GASKET
4	277	1	1	367234183		DRUCKFEDER	5-9	CONICAL COMPRESSION SPRING
4	278	1	1	WJ00213807		PUMPENDECKEL KPL.		PUMP COVER ASSEMBLY
4	279	1	1	WJ00096166		SCHRAUBE		SCREW
4	280	1	1	WJ00098217		FEDER		SPRING
4	281	1	1	WJ00096368		LEERLAUF-STELLSCHRAUBE		IDLE ADJUSTMENT SCREW
4	284	2	2	267485-5		FLACHSCHEIBE	5	FLAT WASHER

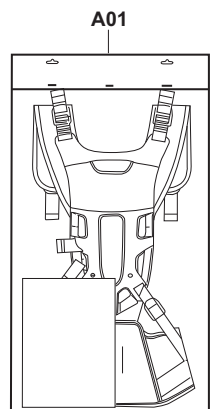
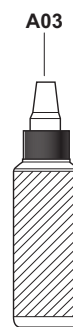
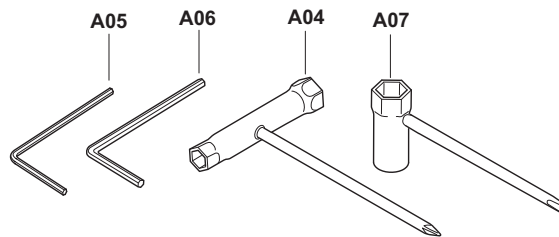
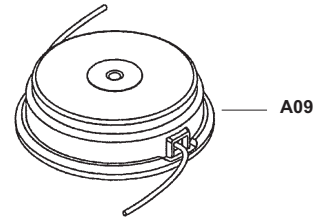
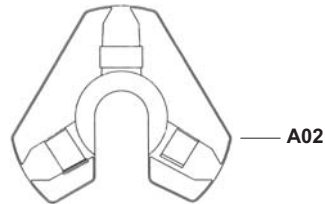
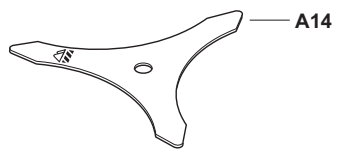
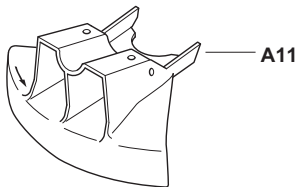
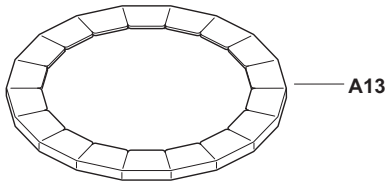
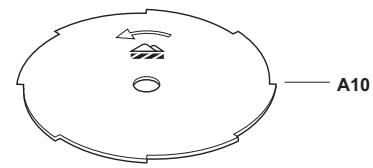

MS43004U, EM4351UH

5

Werkzeuge, Zubehör
Tools, accessories

Seite / Page	Pos.	MS43004U	EM4351UH	Teil-Nr. Part No.	Hinweise Notes	Bezeichnung	Spezifikation Specification	Description
5	A01	1		381196335		SCHULTERGURT KPL.	DOLMAR PROX	BAND ASSEMBLY SET
5	A01	1	1	196129-9		SCHULTERGURT KPL., SET	MAKITA	BAND ASSEMBLY SET
5	A01	1	1	140400-3		KARABINERHAKEN		SNAPHOOK
5	A02	1	1	367451252		TRANSPORTSCHUTZ	3	TOOL COVER
5	A03	1		196721-1		MOTORWARTUNG-SET	SET (MS-430.4 U, MS-4300.4 U) INC. 118,145,218,220,A 03	ENGINE MAINTENANCE KIT
5	A03	1		367242072	PL	ÖLFLASCHE MIT PIPETTE, LEER	w/o oil	OIL BOTTLE WITH PIPETTE
5	A03	1		197010-7		MOTORÖL 4-TAKT	SAE 10W-30, 100ml DOLMAR	MOTOR OIL
5	A03	1	1	195501-2		MOTORÖL	100ml MAKITA	OIL SET
5	A04	1	1	782233-6		KOMBISCHLÜSSEL	SW 10/16	BOX DRIVER
5	A05	1	1	940804000		6 KANT STIFTSCHLÜSSEL	4	HEX. WRENCH
5	A06	1	1	783217-7		6-KT STIFTSCHLÜSSEL	5	HEX. WRENCH
5	A07	1	1	782238-6		STECKSCHLÜSSEL	SW 17	BOX WRENCH
5	A08	1		831315-2	ohne Abb., w/o picture	ZUBEHÖRTASCHE	DOLMAR	ACCESSORY BAG
5	A08	1		831304-7	ohne Abb., w/o picture	ZUBEHÖRTASCHE	MAKITA	ACCESSORY BAG
5	A09	1		197031-9		FADENKOPF	BUMP&FEED ECO6, DOLMAR	NYLON CUTTING HEAD
5	A09	1	1	122882-1		FADENKOPF	ULTRA-AUTO 6, M10x1,25 LH Erstausrüstung	NYLON CUTTING HEAD
5	A10	1	1	385224171	SE	MEISSELZAHN-SÄGEBLATT	ø 200x20	CHISEL TYPE SAW BLADE
5	A10	1		385224161	DE	MEISSELZAHN-SÄGEBLATT	ø 225x20	CHISEL TYPE SAW BLADE
5	A11	1	1	318942-7	SE	SCHUTZHAUBE	200	PROTECTOR
5	A11	1		318943-5	DE	SCHUTZHAUBE	225	PROTECTOR
5	A12	1	1	332051-8	ACC.	AUFNAHMESCHEIBE FÜR MEISSELZAHN-SÄGEBLATT	ø 20	RECEIVE WASHER CHISEL TYPE SAW BLADE
5	A12	1	1	332114-0		AUFNAHMESCHEIBE	ø 25,4	RECEIVE WASHER
5	A13	2	2	367450573		TRANSPORTSCHUTZ		TOOL COVER
5	A14	1		385224150		DICKICHTMESSER	ø 300x25,4	STEEL BUSH CUTTER

- 1** Hauptrohr, Griff, Schutzhaube, Getriebegehäuse
Pipe, handle, protector, gear case
- 2** Bedienungshandgriff kpl.
Control lever ass'y
- 3** Motor kpl.
Motor cpl.
- 4** Vergaser, Luftfilter
Carburetor, air filter
- 5** Werkzeuge, Zubehör
Tools, accessories

	Zeichenerklärung	Key to symbols
=> 1999999 2000000 => 2003.04 => TI 2003/07 Acc. = { m Corr.	Produktion bis Serien-Nr. Neues Teil ab Serien-Nr. Neues Teil ab Jahr / Monat Siehe Technische Information Jahr / Nr. Zubehör (nicht im Lieferumfang) Keine Serienausführung, jedoch verwendbar Beinhaltet Positions-Nr. Meterware Druckfehlerberichtigung	Production to serial number New part from serial number New part from Year / Month See Technical Information Year / No. Accessories (not included in the delivery inventory) No standard execution, may be used Contains item number Sold by the meter Error correction
	Änderungen vorbehalten	Specifications subject to change without notice