

Modell HG650C

Heissluftgebläse 2.000 Watt

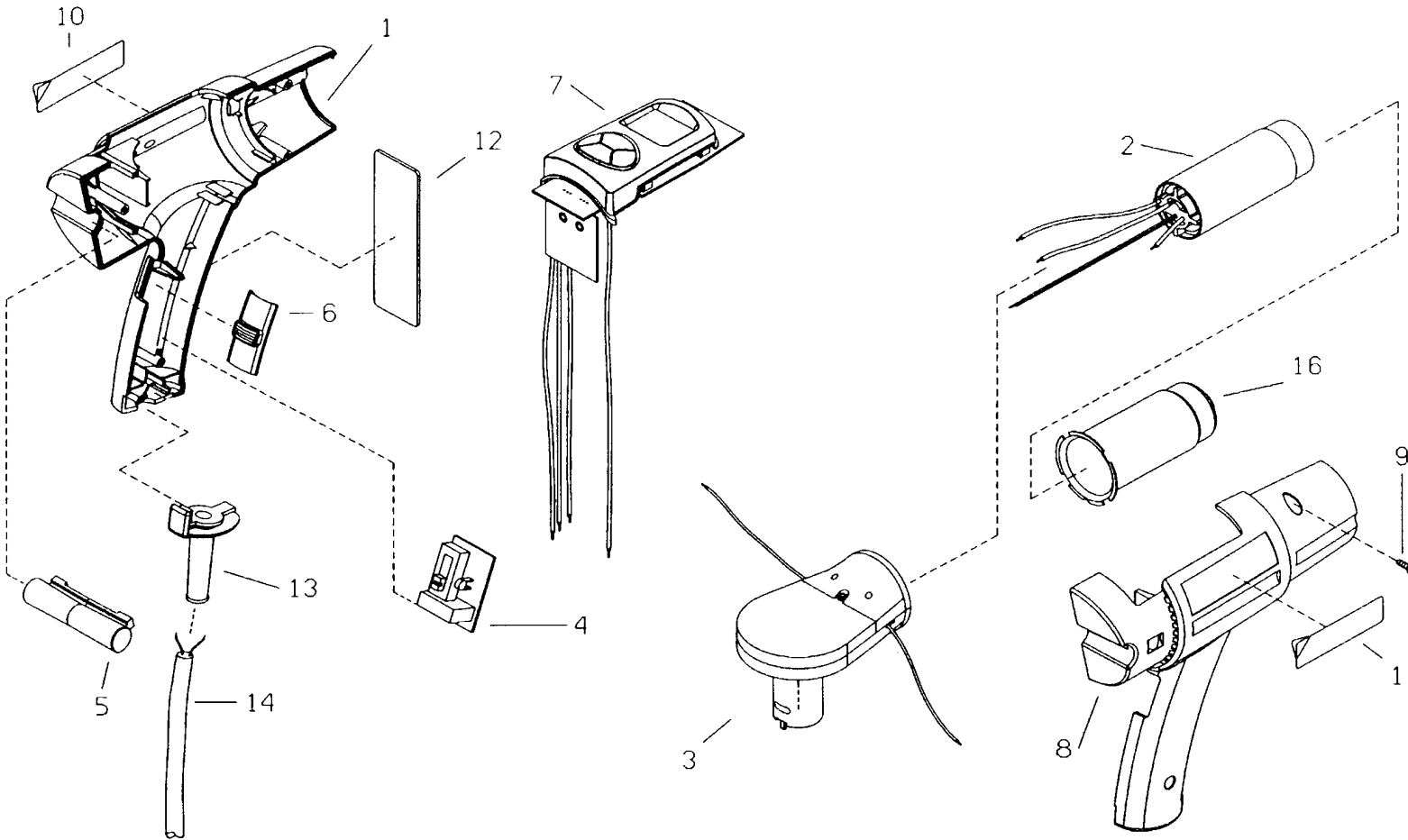

Pos.	*PG	Bestell-Nr.	Bezeichnung
001	22	HG900335	GEHAEUSESCHALE LINKS
002	37	HG900212	HEIZELEMENT 230V
003	31	HG900210	TURBINENEINHEIT
004	22	HG900090	SCHALTER
005	14	HG900015	AUFLAGEGUMMI ROT
006	4	HG900101	SCHALTERSCHIEBER
007	52	HG900208	ANZEIGE KOMPLETT
008	22	HG900336	GEHAEUSESCHALE RECHTS
009	8	HG900086	BLECHSCHRAUBE TORX-S
010	3	HG900340	FIRMENSCHILD
011	3	HG900339	TYPENSCHILD
012	14	HG900020	MOOSGUMMI
013	14	HG900032	KNICKSCHUTZ
014	25	P-12902	ANSCHLUSSLEITUNG 2x1,0mm ²
015			
016	21	HG900025	HEIZELEMENTROHR

Zubehör	
- P-33679	GLASSCHUTZDUESE
- P-33685	BREITSCHLITZDUESE
- P-33691	REDUZIERHUELSE 20mm
- P-33700	REFLEKTORDUESE
- P-33716	SCHWEISSDUESE
- P-33722	UEBERLAPPSCHWEISSDUESE
- P-33738	ANDRUCKROLLE

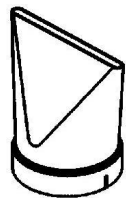

Breitschlitzdüse

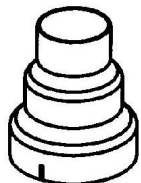

Reduzierdüse

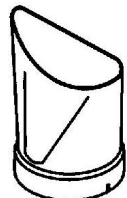

Glasschutzdüse

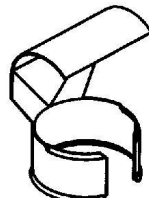

Reflektordüse

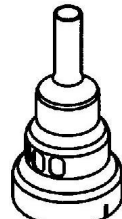

Schweissdüse

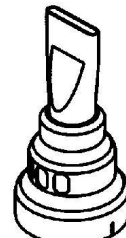

Überlappschweissdüse

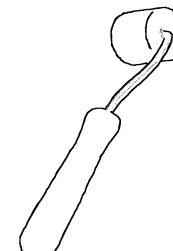

Andruckrolle



Modell HG650C